

Instruction Manual

UM8-40 SERIES

High Voltage Power Supply

MODEL :
SERIAL# :
DATE :

**SPELLMAN
HIGH VOLTAGE ELECTRONICS
CORPORATION**

475 Wireless Blvd.
Hauppauge, New York, 11788

+1(631) 630-3000*FAX: +1(631) 435-1620*

E-mail: sales@spellmanhv.com

Website: www.spellmanhv.com



- **9 VOLTAGE RANGES FROM 8KV TO 40KV, FIXED NEGATIVE OR POSITIVE POLARITY**
- **AVAILABLE OUTPUT POWER INCREMENTS OF 4, 15 AND 30 WATTS**
- **VOLTAGE/CURRENT REGULATION WITH AUTOMATIC CROSSOVER CONTROL**
- **VOLTAGE AND CURRENT MONITOR SIGNALS**
- **FULLY ARC AND SHORT CIRCUIT PROTECTED**
- **PRECISION +5V REFERENCE OUTPUT**
- **COMPREHENSIVE STANDARD INTERFACE**
- **CE LISTED AND RoHS COMPLIANT**

www.spellmanhv.com/manuals/UM8-40

Form, Fit and Function Design:

Spellman's UM Series of printed circuit board mountable, high voltage modules offer a form, fit and function replacement for presently available commercially made units, while providing additional features and benefits at competitive pricing. Utilizing proprietary power conversion technology and Spellman's six decades of high voltage experience, these SMT based high voltage modules provide improved performance/reliability and easier system integration at a lower cost when compared to the competition.

Advanced Power Conversion Topology:

UM converters use a proprietary zero voltage switching power conversion topology providing exceptional efficiency and inherent low noise and ripple. Radiated emissions are reduced compared to conventional switching topologies, minimizing or even eliminating the need to shield the unit from adjacent circuitry.

The high voltage output is generated using a ferrite core high voltage step up transformer which feeds a half wave Cockcroft-Walton voltage multiplier to obtain the specified high voltage output.

Due to the fixed, high frequency conversion rate the output capacitance is small resulting in minimal stored energy. Through the use of generously rated surge limiting resistors and a fast acting current loop, all units are fully arc and short circuit protected.

Control and Regulation:

The actual output voltage generated is sampled via a high impedance divider to create a voltage feedback signal. A current feedback signal is created via a current sense resistor in the low end return of the high voltage output circuitry. These two accurate ground referenced feedback signals are used to precisely regulate and control the units in addition to external monitoring purposes.

Due to the UM's unique converter topology it can provide full current into low impedance loads or even a short circuit. Standard units limit at 103% of maximum rated output current.

Standard Interface:

The Spellman UM Series interface provides current programming capability and positive polarity, buffered, low output impedance voltage and current monitor signals (zero to +4.64Vdc equals zero to full scale rated). A voltage programming input is provided where 0 to +4.64Vdc equals 0 to 100% of rated voltage.

Current programmability allows the user to set where the unit will current limit, anywhere from 0 to 100% of maximum rated current. This feature is beneficial where less than full output current is desired, like in the case of protecting a sensitive load.

The buffered low impedance voltage and current monitor signals can drive external circuitry directly, while minimizing loading and pickup effects. These features save the user the expense and implementation of external interface buffering circuitry while improving overall signal integrity.

This standard interface is made available via a row of 13 pins with 0.1" pin spacing. A legacy interface (7 pins on a 0.2" spacing) that is compatible with presently available commercially made units can be provided by ordering the "L" option.

Mechanical and Environmental Considerations:

The UM Series are solid encapsulated, printed circuit board mountable, plastic cased converters. All units are encapsulated using a silicon based potting material which is considerably lighter in weight than epoxy. Isolated, non grounded 2-56 machine screws thread into the module to securely mount it to the printed circuit board, relieving any stress on the interface pins. Mounting plates, brackets and flanged mounting options are also available. High voltage output is provided via a 36" (914.4mm) minimum length of appropriately rated high voltage wire.

SPECIFICATIONS

Input Voltage:

12Vdc for 4W, 24Vdc for 15W and 30W

Nominal Voltage Range:

11Vdc to 30Vdc for 4W, 23Vdc to 30Vdc for 15W and 30W
4W units can operate at 24Vdc input with no deratings or damage to unit

Input Current: (typical)

Disabled: 10mA @ 24Vdc
Full output, no load: 160mA @ 24Vdc, 300mA @ 12Vdc
Full output, full load:
4 watt units: 330mA @ 24Vdc, 640mA @ 12Vdc
15 watt units: 850mA @ 24Vdc
30 watt units: 1590mA @ 24Vdc

Voltage Regulation:

Line: <0.01% Load: <0.01%

Current Regulation:

Line: <0.01% Load: <0.01%

Stability:

0.01% per 8 hours, 0.02% per day after 30 min. warmup

Accuracy:

2% on all programming and monitoring, except I Sense 10%

Temperature Coefficient: (typical)

Standard: 100ppm/°C
Optional: 25ppm/°C (T Option)

Environmental:

Temperature Range:

Operating: -40°C to 65°C case temperature
Storage: -55°C to 105°C, non operational

Humidity:

10% to 90%, non-condensing.

Cooling:

Convection cooled, typical. 30 watt units operating at full power might require forced air cooling to maintain case temperature below 65°C

Dimensions:

8kV-12kV:
3.700" L X 1.500" W X 0.990" H (93.98mm X 38.10mm X 25.03mm)
15kV-20kV:
4.700" L X 1.500" W X 0.990" H (119.38mm X 38.10mm X 25.03mm)
25kV-40kV:
6.960" L X 1.600" W X 1.14" H (176.78mm X 40.84mm X 28.87mm)

Weight:

8kV-12kV: 5.7 ounces (162 grams), typical
15kV-20kV: 7.2 ounces (204 grams), typical
25kV-40kV: 13.1 ounces (371 grams), typical

Output Cable:

UM8, UM10, UM12, UM15: TV20
UM20, UM25: TV30
UM30, UM35, UM40: TV40

Regulatory Approvals:

Compliant to 2004/108/EC, the EMC Directive and 2006/95/EC, the Low Voltage Directive. Compliant to 2002/95/EC, RoHS

UM 4W, 8kV TO 40kV SELECTION TABLE

Model Number	Output V	Output Current	Ripple(max) %Vp-p	Output Capacitance	Arc Limiting Resistance	I Sense Scaling Full Scale Signal	High Voltage Divider Resistance
UM8*4	0 to 8kV	0.5mA	0.05	6830pF	50kΩ	5V	200MΩ
UM10*4	0 to 10kV	0.4mA	0.05	4380pF	50kΩ	2.4V	300MΩ
UM12*4	0 to 12kV	0.333mA	0.05	4380pF	50kΩ	3.33V	300MΩ
UM15*4	0 to 15kV	0.266mA	0.05	3220pF	100kΩ	1.69V	400MΩ
UM20*4	0 to 20kV	0.2mA	0.05	2310pF	100kΩ	1.316V	550MΩ
UM25*4	0 to 25kV	0.16mA	0.05	1540pF	100kΩ	1.1V	800MΩ
UM30*4	0 to 30kV	0.133mA	0.05	1370pF	120kΩ	0.95V	900MΩ
UM35*4	0 to 35kV	0.115mA	0.05	1370pF	140kΩ	0.72V	900MΩ
UM40*4	0 to 40kV	0.1mA	0.05	1370pF	140kΩ	1.3V	900MΩ

UM 15W, 8kV TO 40kV SELECTION TABLE

Model Number	Output V	Output Current	Ripple(max) %Vp-p	Output Capacitance	Arc Limiting Resistance	I Sense Scaling Full Scale Signal	High Voltage Divider Resistance
UM8*15	0 to 8kV	1.875mA	0.05	6830pF	50kΩ	3.75V	200MΩ
UM10*15	0 to 10kV	1.5mA	0.05	4380pF	50kΩ	8.152V	300MΩ
UM12*15	0 to 12kV	1.25mA	0.05	4380pF	50kΩ	5V	300MΩ
UM15*15	0 to 15kV	1mA	0.05	3220pF	100kΩ	5.53V	400MΩ
UM20*15	0 to 20kV	0.75mA	0.05	2310pF	100kΩ	4.21V	550MΩ
UM25*15	0 to 25kV	0.6mA	0.05	1540pF	100kΩ	3.42V	800MΩ
UM30*15	0 to 30kV	0.5mA	0.05	1370pF	120kΩ	2.89V	900MΩ
UM35*15	0 to 35kV	0.429mA	0.05	1370pF	140kΩ	2.39V	900MΩ
UM40*15	0 to 40kV	0.375mA	0.05	1370pF	140kΩ	4.21V	900MΩ

UM 30W, 8kV TO 40kV SELECTION TABLE

Model Number	Output V	Output Current	Ripple(max) %Vp-p	Output Capacitance	Arc Limiting Resistance	I Sense Scaling Full Scale Signal	High Voltage Divider Resistance
UM8*30	0 to 8kV	3.75mA	0.05	6830pF	50kΩ	5.36V	200MΩ
UM10*30	0 to 10kV	3mA	0.05	4380pF	50kΩ	7.87V	300MΩ
UM12*30	0 to 12kV	2.5mA	0.05	4380pF	50kΩ	5V	300MΩ
UM15*30	0 to 15kV	2mA	0.06	3220pF	100kΩ	5.29V	400MΩ
UM20*30	0 to 20kV	1.5mA	0.06	2310pF	100kΩ	8.15V	550MΩ
UM25*30	0 to 25kV	1.2mA	0.06	1540pF	100kΩ	6.56V	800MΩ
UM30*30	0 to 30kV	1mA	0.06	1370pF	120kΩ	5.52V	900MΩ
UM35*30	0 to 35kV	0.857mA	0.05	1370pF	140kΩ	4.66V	900MΩ
UM40*30	0 to 40kV	0.75mA	0.05	1370pF	140kΩ	8.15V	900MΩ

Grayed text indicates Legacy interface signals.



USA +1-631-630-3000
UK +44 (0)1798 877000
JAPAN +81 (0)48-447-6500
CHINA +86 (0)512-67630010

FAX: +1-631-435-1620
FAX: +44 (0)1798 872479
FAX: +81 (0)48-447-6501
FAX: +86 (0)512-67630030

e-mail: sales@spellmanhv.com
www.spellmanhv.com

128074-001 REV. D

Spellman High Voltage is an ISO 9001:2000 and ISO 14001:2004 registered company

STANDARD INTERFACE

PIN	SIGNAL	PARAMETERS
1	Power Ground Return	+12Vdc or +24Vdc power return/HV return
1A	Signature Resistor	Unique Identifying resistor connected to ground
2	+ Power Input	+12Vdc or +24Vdc power input
2A	N/C	
3	I Sense	See I Sense text and tables for details
3A	I Mon	0 to 4.64Vdc = 0 to 100% rated output. Zout < 10kΩ
4	Enable Input	Low (<0.7V, Isink@1mA)=HV OFF, High (open or >2V)=HV ON
4A	V Mon	0 to 4.64Vdc = 0 to 100% rated output. Zout < 10kΩ
5	Signal Ground	Signal Ground
5A	I Pgm	0 to 4.64Vdc = 0 to 100% rated output. Zin > 47kΩ Leave open for preset current limit @103% of rated output current
6	Remote Adjust	Positive Polarity Unit: 0 to +4.64VDC = 0 to 100% rated voltage, Zin > 1MΩ Negative Polarity Unit: +5VDC to 0.36V = 0 to 100% rated voltage, Zin > 100kΩ Leave open if pin 6A (VPgm) is used for programming
6A	V Pgm	0 to 4.64Vdc = 0 to 100% rated voltage. Zin > 100kΩ Leave open if pin 6 (remote adjust) is used for programming
7	+5V Reference Output	+5Vdc ±1%, 25ppm/°C. Zout =475Ω
8	HV Ground Return	HV Ground Return
9	E Out Monitor	1000:1 ratio. Polarity of Voltage Monitor signal equals polarity of unit. Accuracy is ±2%, 100ppm/°C. Calibrated with DVM with 10MΩ input impedance

Grayed out signals are provided for backward legacy compatability and their use is not required

Power Ground Return, Signal Ground and HV Ground Return are connected internally. For best performance they should not be connected externally.

Standard Interface Connections

Fifteen (15) gold plated 0.025" (0.64mm) square pins suitable for direct PCB mounting. See mechanical drawing for location and spacing details.

Programming and Monitor Signals

Voltage and current programming is done via positive polarity, high input impedance, 0 to 4.64Vdc signals. Voltage and current monitors are positive polarity, buffered low output impedance 0 to 4.64Vdc signals.

I Mon

The I Mon signal is a true output current monitoring signal. All internal offsets due to feedback divider currents have been compensated for.

Signature Resistor

A unique identifying signature resistor for each type of unit is connected from Pin 1A to ground. Details if desired are available upon request.

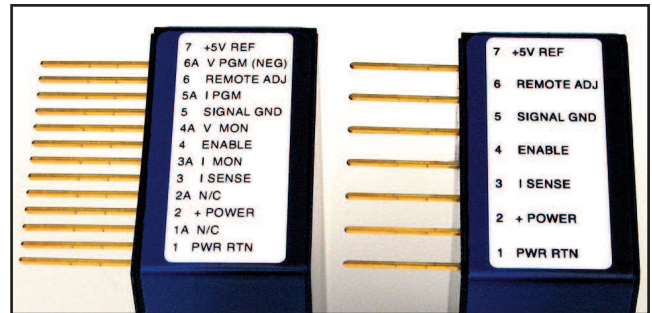

Standard Interface

Legacy Interface

LEGACY INTERFACE (L OPTION)

PIN	SIGNAL	PARAMETERS
1	Power Ground Return	+12Vdc or +24Vdc power return
2	+ Power Input	+12Vdc or +24Vdc power input
3	I Sense	See I Sense text and tables for details
4	Enable Input	Low (<0.7V, Isink@1mA)=HV OFF, High (open or >2V)=HV ON
5	Signal Ground	Signal Ground
6	Remote Adjust	Positive Polarity Unit: 0 to +4.64VDC = 0 to 100% rated voltage, Zin > 1MΩ Negative Polarity Unit: +5VDC to 0.36V = 0 to 100% rated voltage, Zin > 100kΩ
7	+5V Reference Output	+5Vdc ±1%, 25ppm/°C. Zout =475Ω
8	HV Ground Return	HV Ground Return
9	E Out Monitor	1000:1 ratio. Polarity of Voltage Monitor signal equals polarity of unit. Accuracy is ±2%, 100ppm/°C. Calibrated with DVM with 10MΩ input impedance

Power Ground Return, Signal Ground and HV Ground Return are connected internally. For best performance they should not be connected externally.

Legacy Interface Connections

Nine (9) gold plated 0.025" (0.64mm) square pins suitable for direct PCB mounting. See mechanical drawing for location and spacing details.

I Sense Signal

The polarity of the I Sense signal is opposite of the polarity of the output voltage of the unit that generated it. So a positive output polarity unit creates a negative polarity current monitor signal; while a negative output polarity unit creates a positive polarity current monitoring signal. This signal is clamped to ground internally via a bidirectional transient protection device and the signal is made available via a series connected 47kΩ isolation resistor. Internal HV dividers create a small, linear offset voltage on this current monitor signal that can be compensated for.

UM8-40 OPTIONS

C Option

Fast Rise Time Applications-

If applications demand a power supply that is optimized for fast rise time/low overshoot requirements, then the C Option should be considered. A Hysteretic control circuit is employed providing improved performance in these unique applications with higher ripple observed (1% Vpp typical). If used for capacitor charging, a Spellman Capacitor Charging Questionnaire should be filled out to assure all aspects of the intended usage is understood assuring the appropriate unit is provided. Speak to a Spellman sales person for more details.

T Option

Low Temperature Coefficient-

The T Option offers the UM with an improved temperature coefficient. The standard voltage feedback divider is replaced with one having a superior temperature coefficient, resulting in a unit with 25ppm/C° (typical) temperature coefficient.

Maximum short circuit discharge rate:

$$\frac{CV^2}{2} (f) < 1 \text{ watt}$$

C = Output capacitance of unit
 C ext = External capacitance
 V = Maximum rated voltage
 f = Frequency of discharge
 T = Nominal output current
 t_R = Rise time

Typical Rise Time:

$$t_R = \frac{C + C_{ext}}{I} (V)$$

Minimum rise time is 10ms

SHIELDING OPTIONS

M Option

Mu Metal Shield-

UM modules can be fitted with an adhesive backed Mu Metal foil shield to help protect sensitive adjacent circuitry.



Same as standard unit.
 See page 6 of 6 for dimensional drawings

S Option

RF Tight Shielded Can-

The S Option mounts the UM module inside of a flanged RF tight aluminum can.

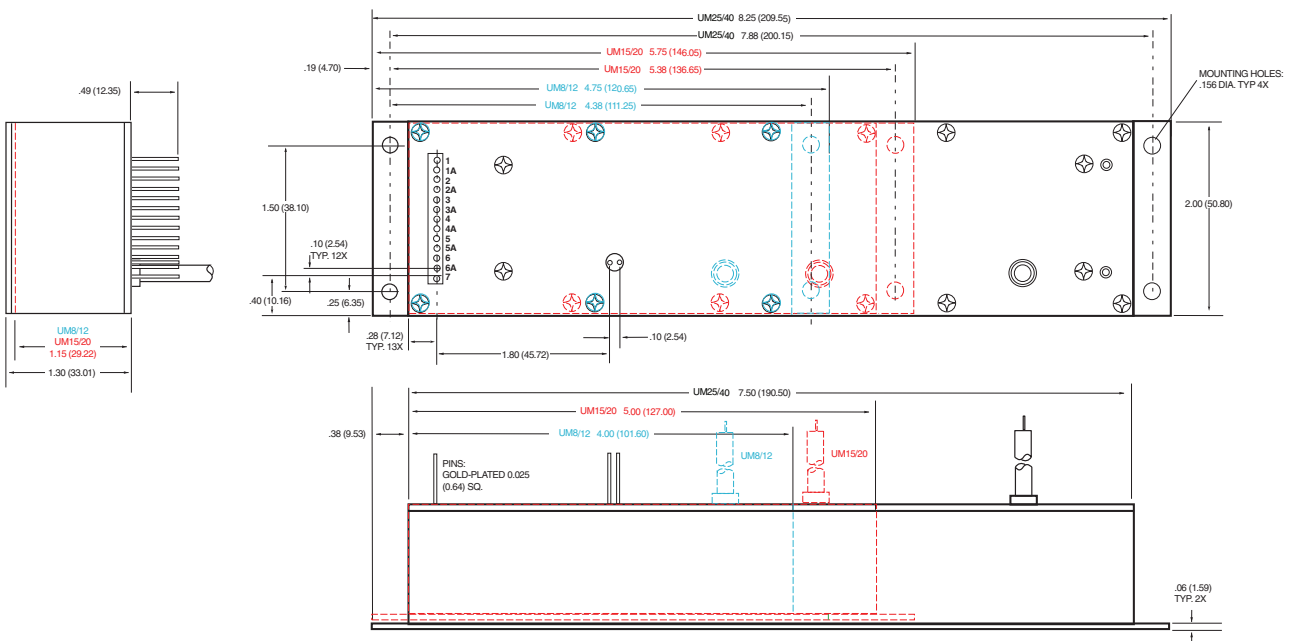

CHASSIS MOUNTING OPTION

E Option

Eared Mounting Plate-

An eared mounting plate is affixed to the top surface of the UM module allowing simple chassis mounting of unit.

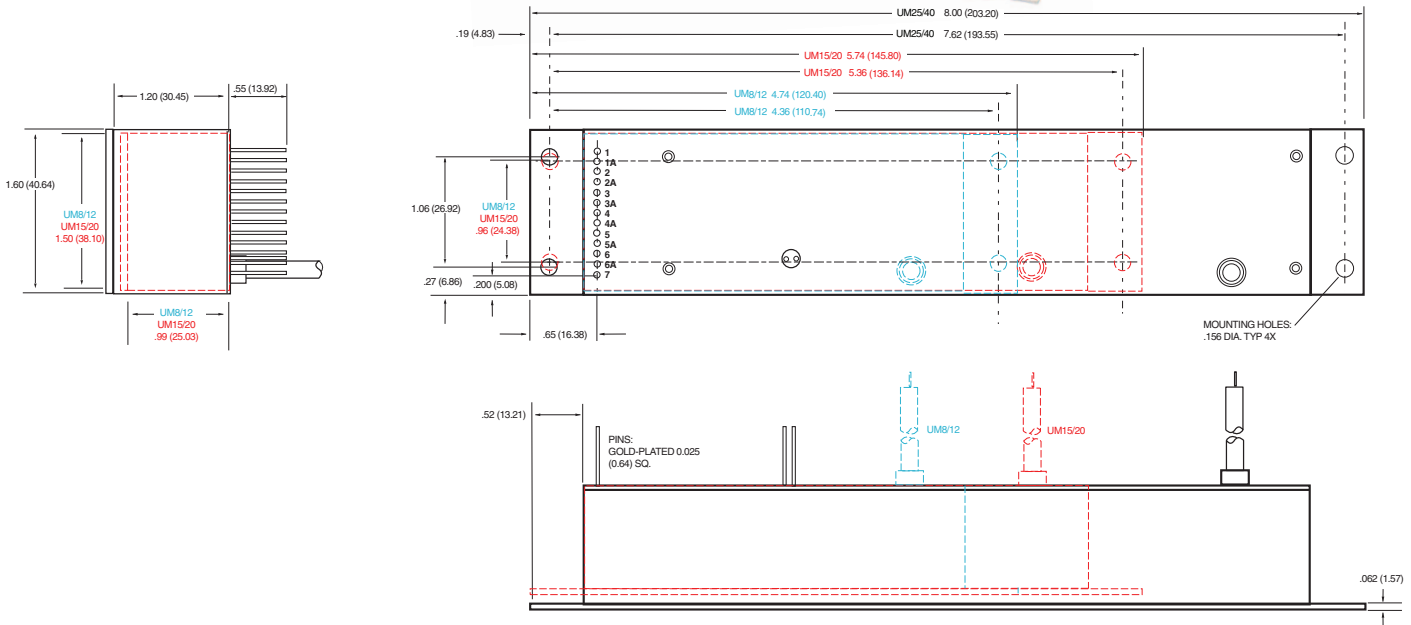
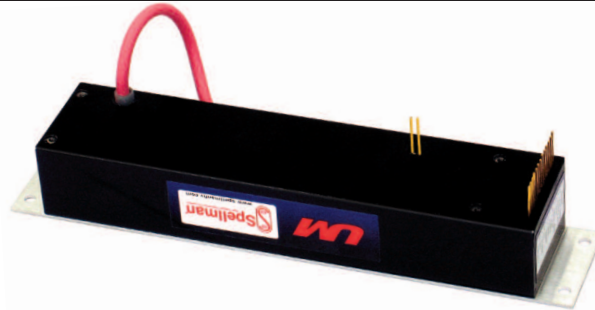

ORDERING INFORMATION

Voltage	0 to 8kV	8
	0 to 10kV	10
	0 to 12kV	12
	0 to 15kV	15
	0 to 20kV	20
	0 to 25kV	25
	0 to 30kV	30
	0 to 35kV	35
	0 to 40kV	40
	Polarity	Positive
Negative		N
Power	Watts Output	4
	Watts Output	15
	Watts Output	30

STANDARD UNIT ORDERING EXAMPLE

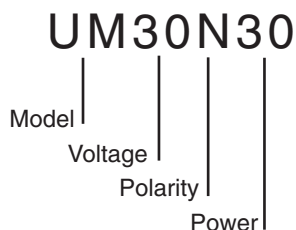

OPTION ORDERING INFORMATION

OPTION	OPTION CODE
Legacy Interface	L
Fast Rise Time	C
Low Temperature Coefficient	T
Mu Metal Shield	M
RF Tight Shielded Can	S
Eared Mounting Plate	E

OPTION ORDERING EXAMPLE

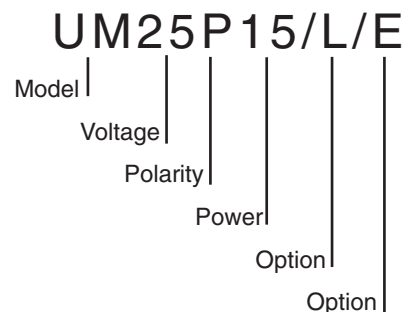

DIMENSIONS: in.[mm]

15 PIN - Standard Interface

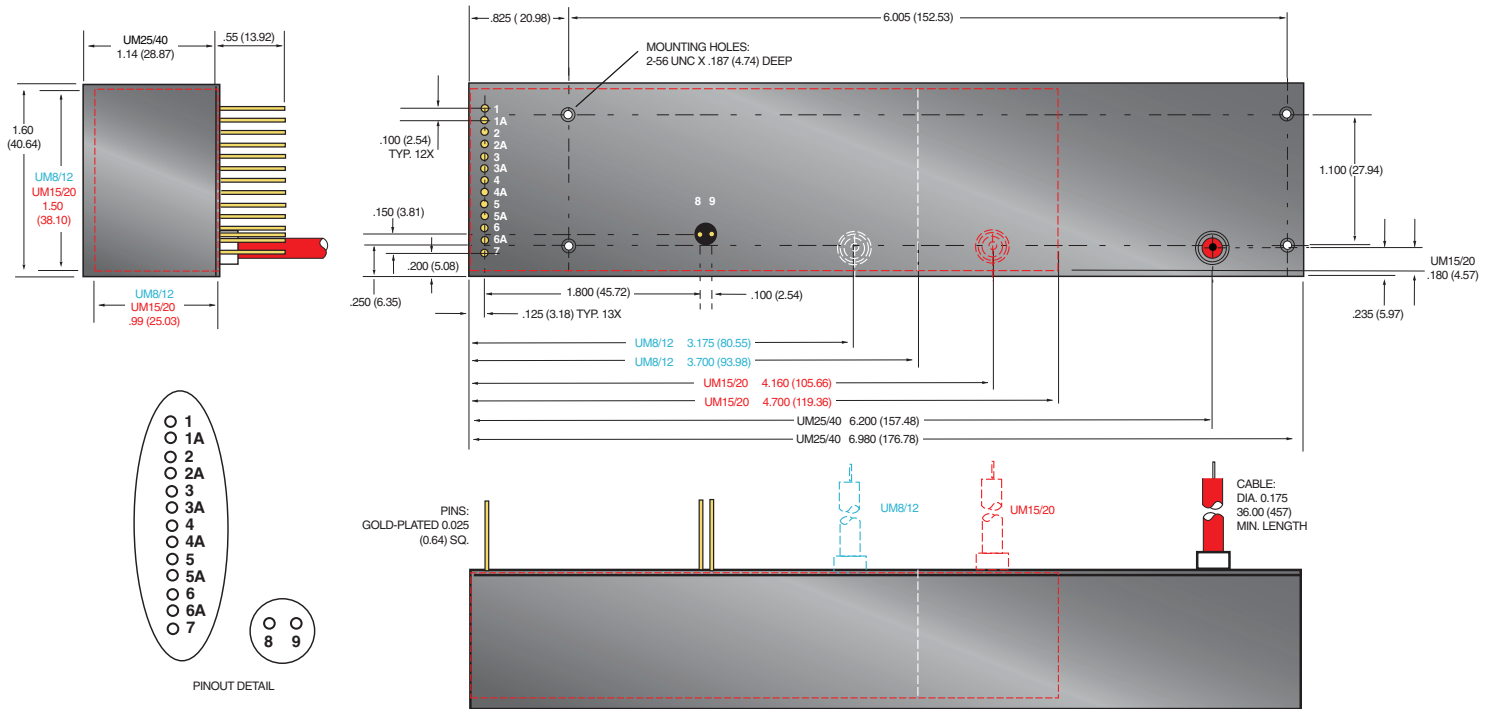

9 PIN - Legacy Interface

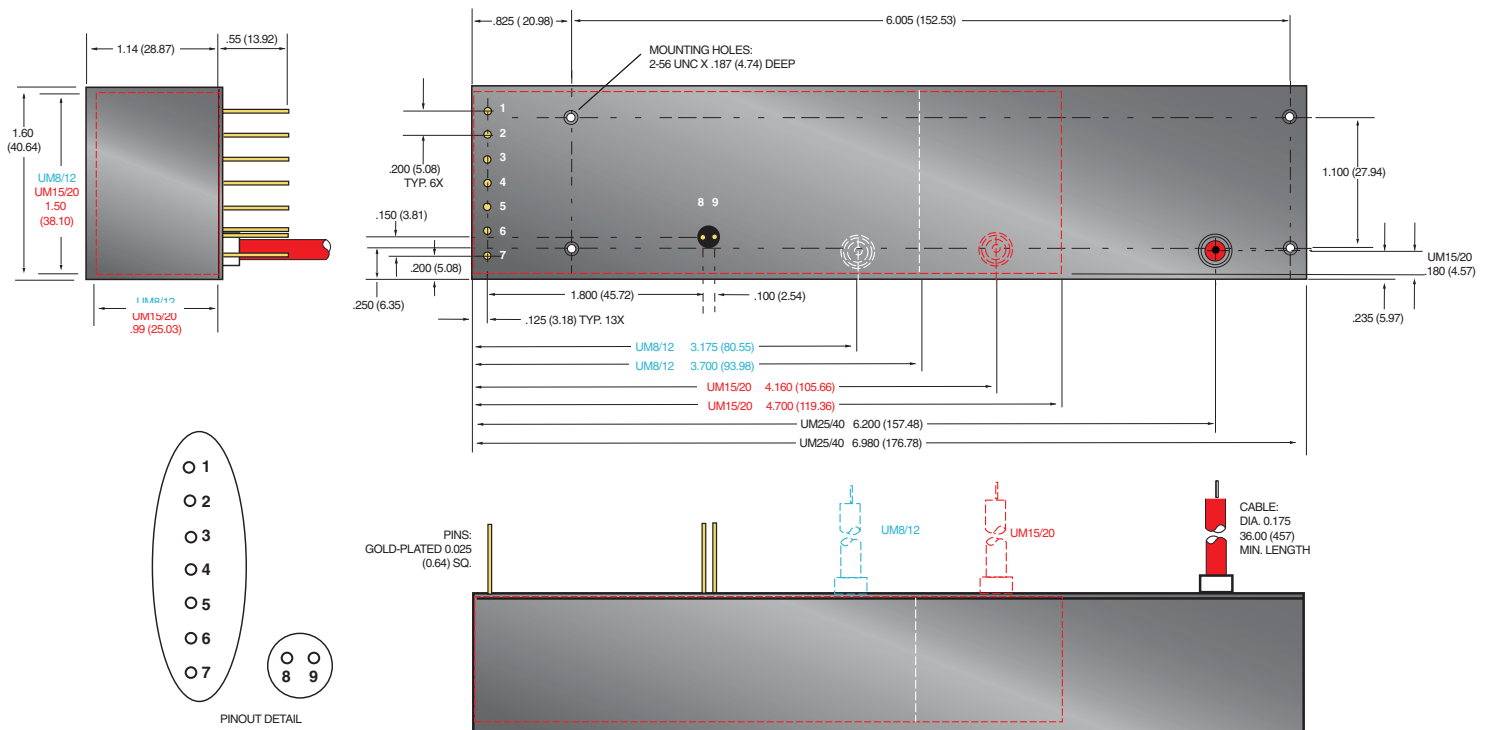

IMPORTANT SAFETY PRECAUTIONS

SAFETY

THIS POWER SUPPLY GENERATES VOLTAGES THAT ARE DANGEROUS AND MAY BE FATAL.
OBSERVE EXTREME CAUTION WHEN WORKING WITH THIS EQUIPMENT.

High voltage power supplies must always be grounded.

Do not touch connections unless the equipment is off and the Capacitance of both the load and power supply is discharged.

Allow five minutes for discharge of internal capacitance of the power supply.

Do not ground yourself or work under wet or damp conditions.

SERVICING SAFETY

Maintenance may require removing the instrument cover with the power on.

Servicing should be done by qualified personnel aware of the electrical hazards.

WARNING note in the text call attention to hazards in operation of these units that could lead to possible injury or death.

CAUTION notes in the text indicate procedures to be followed to avoid possible damage to equipment.

Copyright © 2000, Spellman High Voltage Electronics Corporation. All Rights Reserved.
This information contained in this publication is derived in part from proprietary and patent data. This information has been prepared for the express purpose of assisting operating and maintenance personnel in the efficient use of the model described herein, and publication of this information does not convey any right to reproduce it or to use it for any purpose other than in connection with installation, operation, and maintenance of the equipment described.

WICHTIGE SICHERHEITSHINWEISE

SICHERHEIT

DIESES HOCHSPANNUNGSNETZTEIL ERZEUGT LEBENSGEFÄHRLICHE HOCHSPANNUNG.
SEIN SIE SEHR VORSICHTIG BEI DER ARBEIT MIT DIESEM GERÄT.

Das Hochspannungsnetzteil muß immer geerdet sein.

Berühren Sie die Stecker des Netzteiles nur, wenn das Gerät ausgeschaltet ist und die elektrischen Kapazitäten des Netzteiles und der angeschlossenen Last entladen sind.

Die internen Kapazitäten des Hochspannungsnetzteiles benötigen ca. 5 Minuten, um sich zu entladen.

Erden Sie sich nicht, und arbeiten Sie nicht in feuchter oder nasser Umgebung.

SERVICESICHERHEIT

Notwendige Reparaturen können es erforderlich machen, den Gehäusedeckel während des Betriebes zu entfernen.

Reparaturen dürfen nur von qualifiziertem, eingewiesenem Personal ausgeführt werden.

“WARNING” im folgenden Text weist auf gefährliche Operationen hin, die zu Verletzungen oder zum Tod führen können.

“CAUTION” im folgenden Text weist auf Prozeduren hin, die genauestens befolgt werden müssen, um eventuelle Beschädigungen des Gerätes zu vermeiden.

PRECAUTIONS IMPORTANTES POUR VOTRE SECURITE

CONSIGNES DE SÉCURITÉ

CETTE ALIMENTATION GÉNÈRE DES TENSIONS QUI SONT DANGEUREUSES ET PEUVENT ÊTRE FATALES.
SOYEZ EXTRÊMEMENT VIGILANTS LORSQUE VOUS UTILISEZ CET ÉQUIPEMENT.

Les alimentations haute tension doivent toujours être mises à la masse.

Ne touchez pas les connectiques sans que l'équipement soit éteint et que la capacité à la fois de la charge et de l'alimentation soient déchargées.

Prévoyez 5 minutes pour la décharge de la capacité interne de l'alimentation.

Ne vous mettez pas à la masse, ou ne travaillez pas sous conditions mouillées ou humides.

CONSIGNES DE SÉCURITÉ EN CAS DE REPARATION

La maintenance peut nécessiter l'enlèvement du couvercle lorsque l'alimentation est encore allumée.

Les réparations doivent être effectuées par une personne qualifiée et connaissant les risques électriques.

Dans le manuel, les notes marquées « **WARNING** » attire l'attention sur les risques lors de la manipulation de ces équipements, qui peuvent entraîner de possibles blessures voire la mort.

Dans le manuel, les notes marquées « **CAUTION** » indiquent les procédures qui doivent être suivies afin d'éviter d'éventuels dommages sur l'équipement.

IMPORTANTI PRECAUZIONI DI SICUREZZA

SICUREZZA

QUESTO ALIMENTATORE GENERA TENSIONI CHE SONO PERICOLOSE E POTREBBERO ESSERE MORTALI.
PONI ESTREMA CAUTELA QUANDO OPERI CON QUESTO APPARECCHIO.

- Gli alimentatori ad alta tensione devono sempre essere collegati ad un impianto di terra.
- Non toccare le connessioni a meno che l'apparecchio sia stato spento e la capacità interna del carico e dell'alimentatore stesso siano scariche.
- Attendere cinque minuti per permettere la scarica della capacità interna dell'alimentatore ad alta tensione.
- Non mettere a terra il proprio corpo oppure operare in ambienti bagnati o saturi d'umidità.

SICUREZZA NELLA MANUTENZIONE.

- Manutenzione potrebbe essere richiesta, rimuovendo la copertura con apparecchio acceso.
- La manutenzione deve essere svolta da personale qualificato, coscio dei rischi elettrici.
- Attenzione alle **AVVERTENZE** contenute nel manuale, che richiamano all'attenzione ai rischi quando si opera con tali unità e che potrebbero causare possibili ferite o morte.
- Le note di **CAUTELA** contenute nel manuale, indicano le procedure da seguire per evitare possibili danni all'apparecchio.

Table of Contents

	PAGE
1. INTRODUCTION	
1.1 Description of the UM8-40 Series	1
1.2 Standard Features.....	1
1.3 Remote Operating Features.....	1
1.4 Options.....	2
1.5 Interpreting the Model Number	2
2. INSPECTION & INSTALLATION	
2.1 Initial Inspection	3
2.2 Mechanical Installation.....	3
3. OPERATING INSTRUCTIONS	
3.1 Operation.....	5
3.2 Standard Features.....	6
4. PRINCIPLES OF OPERATION	
4.1 DC Input.....	9
4.2 Inverter.....	9
4.3 High Voltage Transformer.....	9
4.4 High Voltage Output Section.....	9
4.5 Control Circuitry.....	9
5. OPTIONS	
5.1 L Option – Legacy Interface.....	11
5.2 C Option – Fast Rise Time.....	11
5.3 T Option – Low Temperature Coefficient.....	11
5.4 M Option – Mu Metal Shield.....	12
5.5 S Option – RF Tight Shielded Can.....	12
5.6 E Option – Eared Mounting Plate.....	12
5.7 X Numbered Units – Custom Options.....	12
6. MAINTENANCE	
6.1 Periodic Servicing.....	13
6.2 Performance Tests.....	13
6.3 High Voltage Dividers.....	13
7. FACTORY SERVICE	
7.1 Warranty Service	14
7.2 Factory Service Procedures.....	14
7.3 Shipping Instructions	14

LIST OF FIGURES

Figure 1	Outline Dimensions	4
Figure 2	Grounding	7
Figure 3	Remote Programming with a Remote Voltage Source	7
Figure 4	Programming using the +5V Reference.....	7
Figure 5	Remote Voltage and Current Monitoring	8
Figure 6	Enable Input	8
Figure 7	Block Diagram	10

Chapter 1

INTRODUCTION

1.1 Description of the UM8-40 Series

Spellman's UM8-40 Series of printed circuit board mountable, high voltage modules offer a form, fit and function replacement for presently available commercially made units, while providing additional features and benefits. Utilizing proprietary power conversion technology these SMT based high voltage modules provide improved performance, reliability and easy system integration.



The UM8-40 is available in three power ranges of 4, 15 and 30 watts with output voltages spanning from 15kV to 40kV with fixed positive or negative polarities. Voltage & Current loops with automatic cross over control regulate the output into any load condition. The UM8-40 is a reliable and robust series that is arc and short circuit protected. The comprehensive standard interface provides interfacing flexibility and all UM8-40 units are CE and RoHS compliant.

1.2 Standard Features

The UM8-40 Series incorporates several standard features designed to optimize user satisfaction and safety:

- **Slow Start:** A 10 millisecond slow start time constant assures quick yet fully controllable risetime of the high voltage output.
- **Current Regulating Loop:** Current programmability allows the user to set where the unit will current limit, anywhere from 0 to 100% of maximum rated current.
- **0 to +4.64Vdc Programming Inputs:** Positive polarity, high impedance, ground referenced 0 to 4.64Vdc voltage programming inputs correspond to 0 to 100% rated voltage and current outputs.

- **0 to +4.64Vdc Monitor Outputs:** Positive polarity, low impedance, ground referenced 0 to 4.64Vdc voltage monitor outputs correspond to 0 to 100% rated output voltage and current.

- **Precision +5Vdc Reference Output:** A precision micro power band gap reference of +5Vdc, $\pm 0.5\%$, 25ppm/ $^{\circ}\text{C}$ with an output impedance of 475 Ω is provided to simplify remote programming of the power supply.

- **Arc and Short Circuit Protected:** Due to the fixed, high frequency conversion rate the UM8-40s output capacitance is small resulting in minimal stored energy. Through the use of generously rated surge limiting resistors and a fast acting current loop, all units are fully arc and short circuit protected.

1.3 Remote Operating Features

- **Enable Input:** The Enable Input allows the user to easily control the HV ON/HV OFF status of the power supply. HCMOS compatible signals A low (<1.5Vdc) enable input signal equals HV OFF, while a high (open or >3Vdc) enable signal equals HV ON.

Warning!

The Enable Input should not be used as for protection against user injury or for a safety interlock function.



1.4 Options

Several standard options are available to customize your UM for you application.

- L Option – Legacy Interface
- C Option – Fast Rise Time
- T Option – Low Temperature Coefficient

- M Option – Mu Metal Shield
- S Option – RF Tight Shielded Can
- E Option – Eared Mounting Plate
- X Numbered Units – Custom Options

1.5 Interpreting the Model Number

The power supplies model number describes its capabilities. Model numbers are configured as follows:

UM25P15/L/E where:

- UM** is the product series name
- 25** is the maximum output voltage in kV
- P** is the output polarity
- 15** is the output power in watts
- L** is the Legacy Interface
- E** is the Eared Mounting Plate

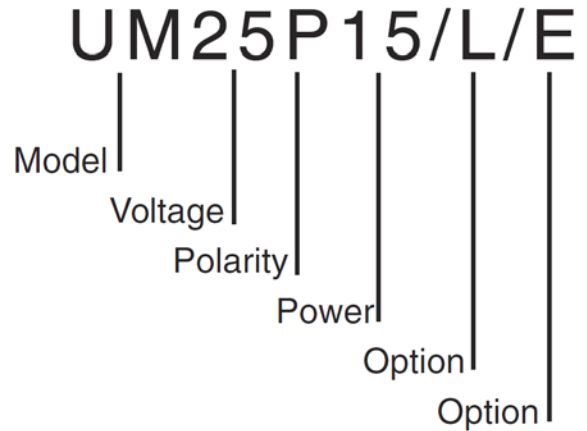

X numbered units are unique units custom developed for specific application requirements above and beyond the scope of the available standard options. Each 4 digit X number corresponds to an applicable specification control drawing.

Chapter 2

INSPECTION & INSTALLATION

Initial inspection and preliminary checkout procedures are recommended. For safe operation, please follow the procedures described in Chapter 3, Operating Instructions.

2.1 Initial Inspection

Inspect the packaging exterior for evidence of damage due to improper handling in transit. Notify the carrier and Spellman High Voltage immediately if damage is evident. Do not destroy or remove any of the packing material used in a damaged shipment.

After unpacking inspect the power supply for any visible signs of damage.

2.2 Mechanical Installation

Standard UM8-40 modules are intended for direct printed circuit board mounting, it is recommended that the unit be processed in a hand solder operation only.

Solder iron tip temperatures are most commonly between 315-371°C (600-700°F) for Sn63/Pb37 alloys and between 371-427°C (700-800°F) for Sn96.5/Ag3.0/Cu0.5 lead-free alloys.

Heat both the land area and component lead to be soldered with the iron prior to adding cored wire. Apply the solder wire to the land area or component lead. Do not apply the wire directly to the soldering iron tip. Do not apply solder iron to joint for a period exceeding 15 seconds.

Process and inspect workmanship to IPC-A-610 class 2 standards as applicable.

2-56 pan head stainless steel screws are provided to mechanically secure the unit to the printed circuit board assembly. Tighten the screws to 3 inch/pounds (0.34N•m) of torque.

Do not use longer screws than those provided, otherwise risk of damage to the unit is possible. The mounting screws are electrically isolated, they are not connected to any potential or ground point inside the power supply. Please see the UM8-40 data sheet for a more detailed dimensional drawing.

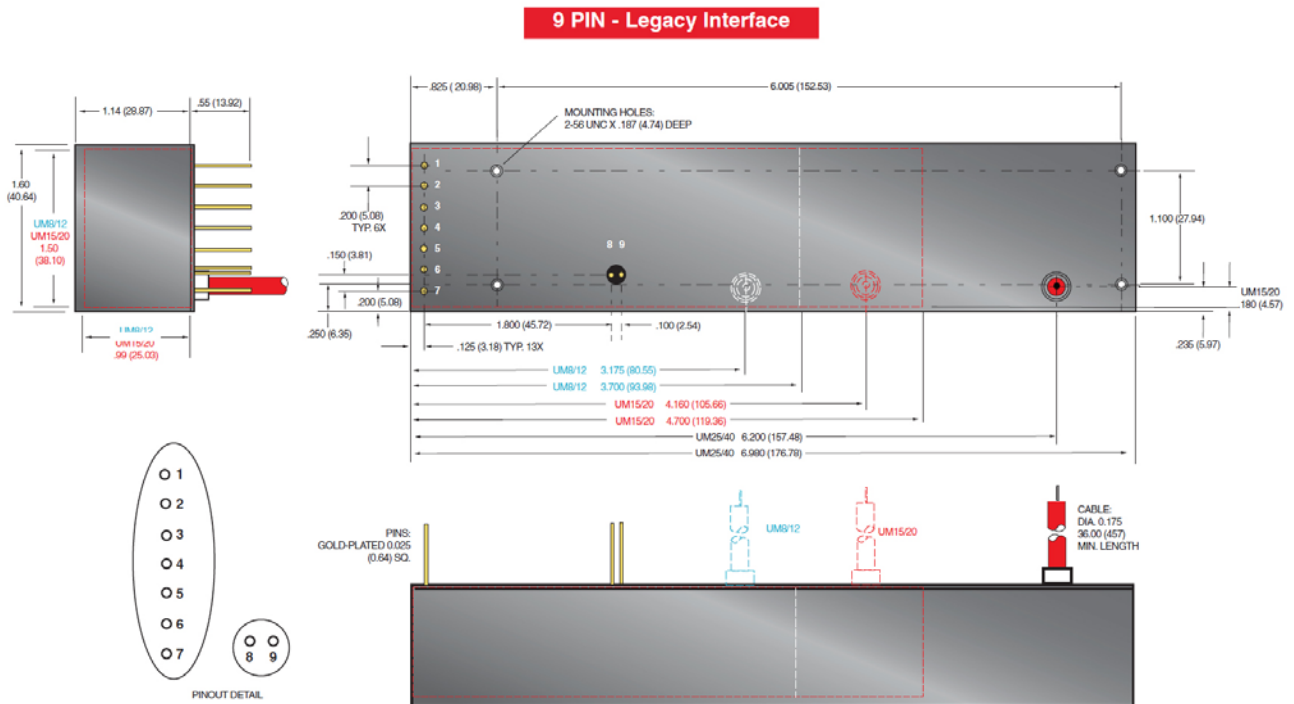
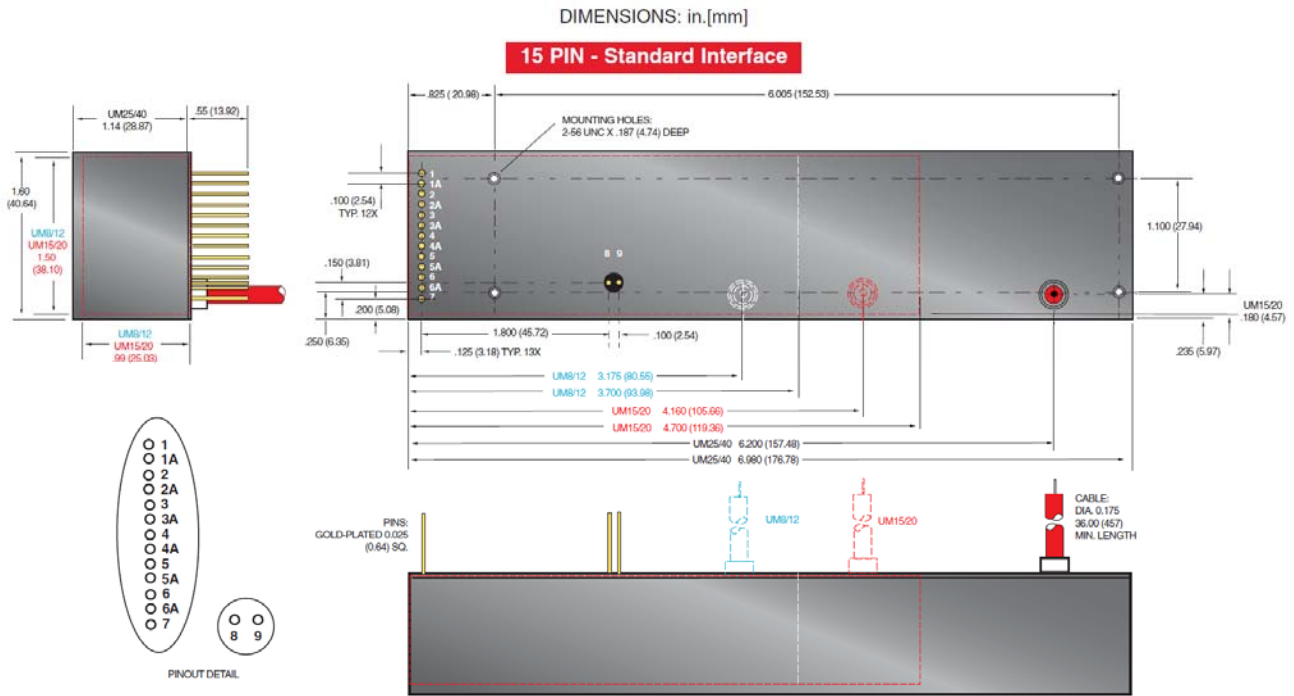

Figure 1 Outline Dimensions

Chapter 3

Operating Instructions

3.1 Operation

WARNING!

This equipment generates dangerous voltages that may be fatal.

Proper grounding of all high voltage equipment is essential.

It is highly recommended that all testing comply with IEEE Standard 510-1983 IEEE Recommended Practices for Safety in High Voltage and High Power Testing. A copy of this standard can be downloaded from the Spellman High Voltage website [here](#).



INPUT VOLTAGE

Check the identification label on the power supply and confirm it matches the input voltage of the source supply that will be used to power the UM8-40 module. 4 watt units operate off +12Vdc, while 15 and 30 watt units operate off +24Vdc. If a 4 watt unit is connected to +24Vdc, the unit will operate properly meeting all specifications. If a 15 or 30 watt unit is connected to +12Vdc, no damage will occur but the unit may not perform properly.

HIGH VOLTAGE CONNECTION

Insure that high voltage connection is properly terminated to the load. Confirm that adequate air isolations spacings exist for the maximum voltage of the power supply, using the guideline of 10kV per inch (25.4mm) to any points that will be elevated to high voltage. All accessible high voltage points should be enclosed in a protective Faraday enclosure. Any access panels on the safety enclosure should be interlocked.

UM8-40 MANUAL

GROUNDING

Proper grounding of the unit is essential for reliable operation. Power Ground, Signal Ground and HV Ground Return are connected internally. For best performance they should not be connected externally.

The Power Ground connection (Pin 1) carries the +12Vdc or +24Vdc current that powers the unit, make this connection adequate enough to handle 2 amps, minimum. Additionally it is recommended that this connection be used to tie the power supply to whatever potential is used as the local "system ground".

Signal grounds relating to programming and monitor functions should be referenced to the UM8-40's Signal Ground (Pin5).

A physical load return connection must be made from the bottom of the load to the power supplies HV Ground Return (Pin 8).

See Figure 2 for details.

OPTIONS

See Section 5 of this manual for setup and operating instructions if the unit under test has any options. Custom X numbers units may also require special test requirements; consult the unit's specification control drawing for details.

SIGNAL CONNECTIONS

Connect the appropriate programming and monitoring signals to the unit as detailed in the figures in this chapter.

INITIAL TURN ON

- A) Set the voltage and current programming inputs for zero output (Pin 6A and 5A respectively). Ground the Enable Input (Pin 4), to assure the unit is in HV OFF mode.
- B) The DC input power can now be connected.
- C) Enable the power supply by opening the Enable Input (Pin 4).

- D) Set the current programming level (Pin 5A) to just above the current anticipated that will be drawn from the power supply or leave open for preset current to 103% of rated current.
- E) Slowly increase the voltage programming (Pin 6A) while monitoring the voltage and current monitors (Pin 4A and 3A respectively). Carefully note proper equipment operation and that the load is behaving as predicted.
- F) To turn the HV OFF ground the Enable Input (Pin 4). If the equipment is to be left off for an extended period of time or service of the unit or load is required turn off the DC input power.

Legacy Interface Units:

Negative output polarity units are programmed such that 5.0Vdc to 0.36Vdc equals 0 to 100% of rated output voltage

WARNING!

After turn off do not touch anything that has been connected to the output of the power supply. Wait a minimum of 5 minutes, and then discharge any remaining stored energy by connecting the high voltage output to ground. Failure to follow these safety warnings can result in injury or death.



3.2 Standard Features

Programming and monitoring of the UM8-40 is accomplished via the use of conventional positive polarity, ground referenced signals. All signal inputs and outputs are noise filtered, impedance protected and diode clamped providing an easy to use, robust analog customer interface. Excellent results have been obtained via the use of standard engineering design guidelines like twisted pair, shielded cables, the prudent dressing of interface wiring away from possible noise sources, short cable runs and adhering to a well thought out and executed grounding topology.

REMOTE PROGRAMMING

The UM8-40's programming and monitor signals are based upon a universal, positive polarity, ground referenced signal such that 0 to 4.64Vdc corresponds to 0 to 100% rated output.

Programming can be accomplished via the use of an applicable customer provided ground referenced voltage source that meets the mentioned requirements. See Figure 3 for details.

If such a source is not available a precision +5Vdc reference is provided on Pin 7. A simple adjustable voltage divider can be created using this reference and an external potentiometer(s) which will provide full control of the voltage and current loops. See Figure 4 for details.

REMOTE MONITORING

The voltage and current monitor signals have adequate bandwidth capability to accurately represent the actual respective output within the dynamic limits of the power supply. See Figure 5 for details.

ENABLE INPUT

The enable input signal provides simple control of the ON/OFF functionality of the high voltage output. See Figure 6 for details.

WARNING!

It is extremely dangerous to use this circuit to inhibit high voltage generation for the purpose of servicing or approaching any area considered unsafe during normal usage.



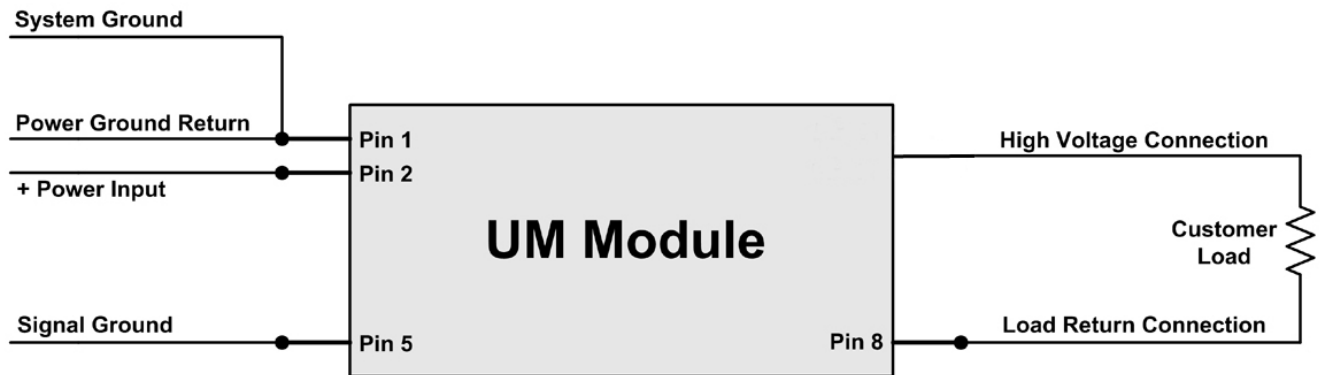

Figure 2 – Grounding

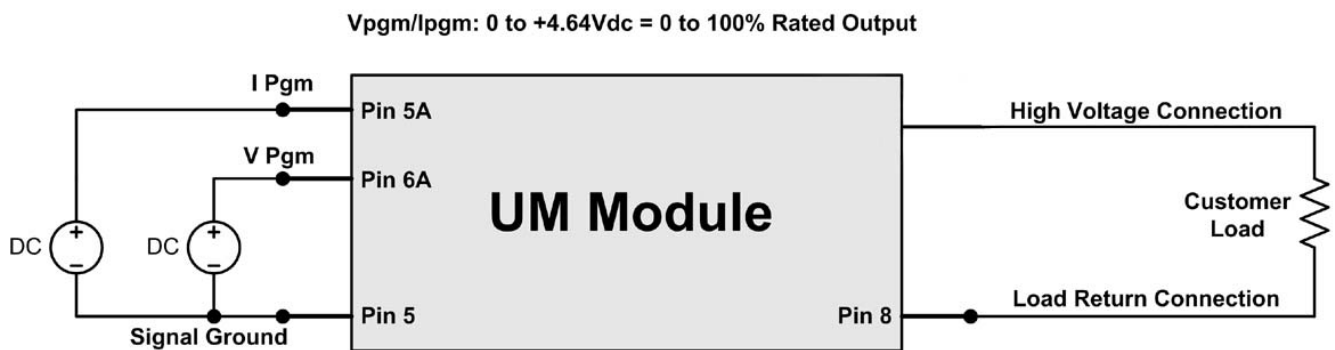
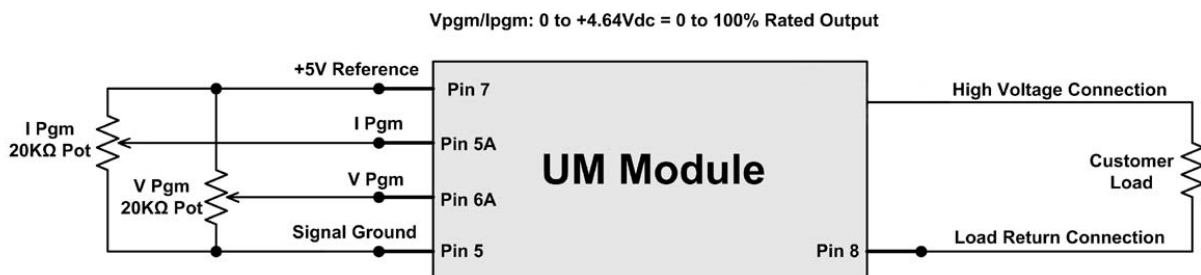

Figure 3 – Programming with a Remote Voltage Source



Note:
 The +5V reference output (pin 7) is provided via an internal 475Ω inline series resistor for transient and short circuit protection. Take this impedance into account when selecting the resistance value of external programming potentiometers. Use 20K pots if both voltage and current adjustments are used as shown above. Use a 10K pot if only one pot is used and the other programming input is pulled up directly to +5V. The use of excessively low resistance values of programming potentiometers will create a significant voltage divider against the internal 475Ω series resistor resulting in the inability of programming the power supply to its maximum voltage and current outputs.

Figure 4 – Programming using the +5V Reference

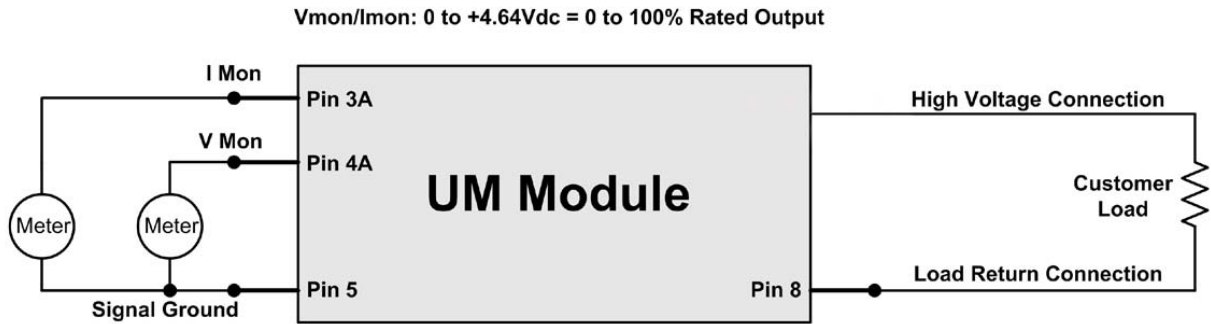

Figure 5 – Remote Voltage and Current Monitoring

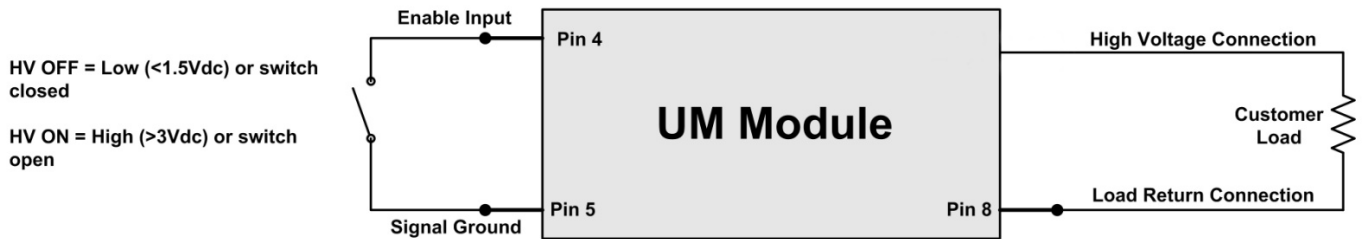

Figure 6 – Enable Input

External Capacitance:

For standard units (non C Option) placing large external capacitance on the output may result in operational instability. As a general rule of thumb, external capacitance should satisfy the equation:

$$C_{\text{external}} < 0.1 \text{ millisecond} / R_{\text{limit}}$$

where R_{limit} is the applicable arc limiting resistance specified in the UM8-40 selection table on page 2 of 6 of the UM8-40 data sheet.

For fast risetime units (C Option) no value of external capacitance will make the unit unstable.

Chapter 4

Principles of Operation

Warning!

The energy levels used and generated by the power supply can be lethal! Do not attempt to operate the power supply unless the user has a sufficient knowledge of the dangers and hazards of working with high voltage. Do not attempt to approach or touch and circuits that are connected to or have been connected to the power supply. Be certain to discharge any stored energy that may be present before and after the power supply is used. Consult IEEE recommended practices for safety in high voltage testing document number 510-1983.



4.1 DC Input

The UM8-40 is a DC to DC converter. Within the power supply conversions from low voltage DC, to low voltage AC, to high voltage AC and finally to high voltage DC takes place. The DC input (either +12Vdc or +24Vdc) powers both the power conversion circuitry that creates the high voltage output, along with the low voltage DC housekeeping voltages that provide power to the affiliated support control circuitry.

4.2 Inverter

The DC input voltage is fed to the Inverter circuitry. Here the low voltage DC is converted to a low voltage, high frequency AC signal. This power conversion step allows for all subsequent power processing to take advantage of component miniaturization due to the high operational frequency. The Inverter functionality is controlled via the power supplies regulating loops which allows for complete command of the desired output voltage and current.

4.3 High Voltage Transformer

The high voltage transformer is a ferrite core step up type in which the primary is driven from the output of the Inverter circuit. The secondary of the high voltage transformer feeds the High Voltage Output Section.

4.4 High Voltage Output Section

The High Voltage Output Section utilizes an arrangement of half wave Cockcroft-Walton voltage multiplier stages to obtain the necessary output voltage.

The actual output voltage is sampled via a high impedance divider to create a voltage feedback signal. A current feedback signal is created via a current sense resistor in the low end return of the High Voltage Output Circuitry. These two accurate ground referenced feedback signals are used to precisely regulate and control the unit, in addition to providing external monitoring.

4.5 Control Circuitry

Various SMT based control circuitry is used for all interfacing, monitoring and regulation functionality of the UM8-40 modular power supply.

The voltage and current feedback signals generated in the High Voltage Output Section are compared to the requested voltage and current commands from the remote interface. The voltage or current loop error amplifier creates the appropriate error signal which is provided to the Pulse Width Modulation (PWM) circuitry.

The output of the PWM circuitry drives the Inverter circuit to provide the required output in a continuous closed loop control process, regulating in either voltage mode or current mode as required.

The internally generated voltage and current feedback signals are processed and provided to the remote interface for monitoring purposes.

A precision +5Vdc, $\pm 0.5\%$, 25ppm/ $^{\circ}\text{C}$ micro power band gap reference output is provided for user programming convenience.

The Enable Input from the remote interface controls the HV ON and HV OFF status of the power supply by interfacing with the PWM circuitry.

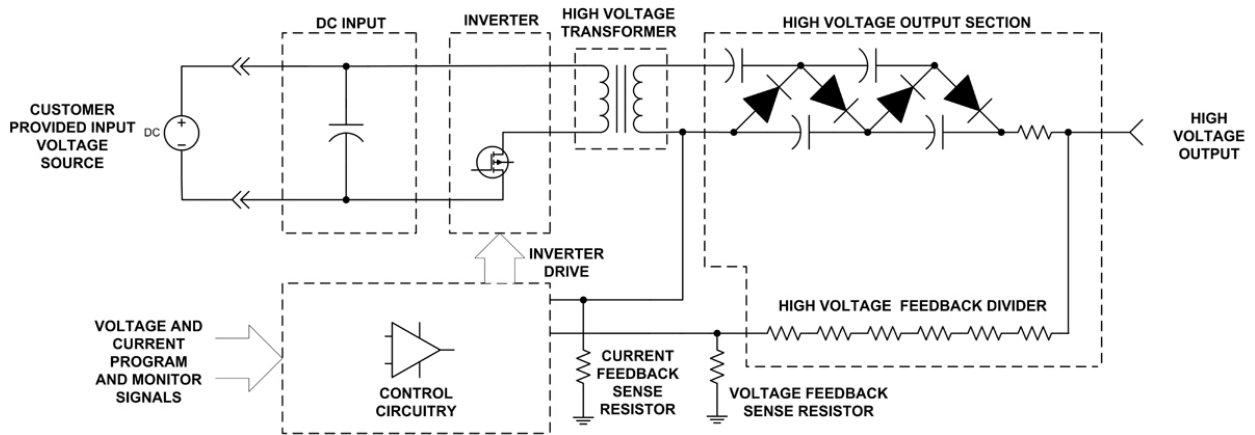
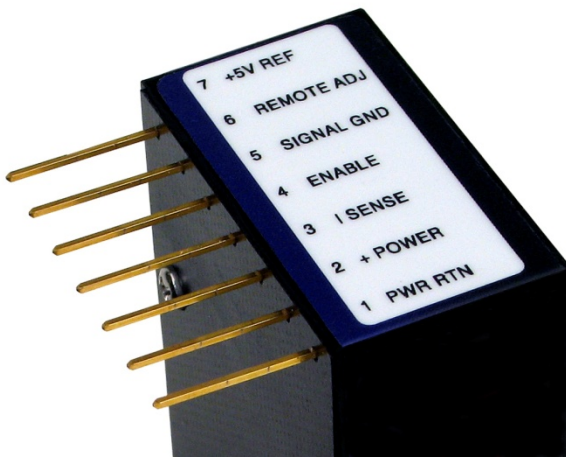

Figure 7 - Block Diagram

Chapter 5

OPTIONS

5.1 L Option - Legacy Interface



The Legacy Interface provides form, fit and function replacement for presently available commercially made units.

The standard UM8-40 is provided with a row of 13 interface pins on 0.1" center spacing. By removing "every other pin" the Legacy Interface provides 7 pins on 0.2" center spacing. Physically the UM8-40 with the Legacy Interface will fit into printed circuit boards designed for other commercially made units. A standard unit can be turned into a Legacy Interface unit by clipping the appropriate interface pins.

Functionality wise the Legacy Interface is electrically identical to other commercially made units so interface compliance is guaranteed.

5.2 C Option – Fast Rise Time

The C Option optimizes the UM8-40 for fast rise time/low overshoot requirements. A Hysteretic control circuit is employed providing improved performance. If used for capacitor charging, a Spellman Capacitor Charging Questionnaire should have been filled out to assure all aspects of the intended usage were reviewed assuring the appropriate unit was selected.

Typical rise times can be calculated using the following formula:

$$t_{RISETIME} = (V)(C + C_{EXT})/I$$

Where:

C = Output Capacitance of Unit
C_{EXT} = External Capacitance
I = Nominal Output Current
V = Maximum Rated Voltage

Where the minimum risetime shall never be less than 3ms.

Considering the maximum short circuit discharge rate is important in fast rise time applications. Energy is stored in the capacitance of the High Voltage Output Section of the unit. Output limiting resistors located inside the unit are electrically connected series with the output. These resistors limit the short circuit discharge current to a safe level. During short circuiting all the energy stored in the High Voltage Output Section is dissipated as heat in the output limiting resistors. If the repetitive short circuit discharge rate is too great the internal limiting resistors can get damaged due to thermal overload. Maximum short circuit discharge rates can be calculated as follows:

$$(CV^2)(f) < 1 \text{ watt}$$

Where:

C = Output Capacitance of Unit
V = Rated Output Voltage of Unit
f = Frequency of Discharge

5.3 T Option – Low Temperature Coefficient

The T Option offers the UM8-40 with an improved temperature coefficient. The standard voltage feedback divider is replaced with one having a superior temperature coefficient, resulting in a unit with 25ppm/C° (typical) temperature coefficient.

5.4 M Option – Mu Metal Shield



The M Option fits the UM8-40 with an adhesive backed Mu Metal foil shield to help protect sensitive adjacent circuitry. See data sheet for dimensional drawing.

5.5 S Option – RF Tight Shielded Can



The S Option mounts the UM8-40 module inside of a flanged RF tight aluminum can. See data sheet for dimensional drawing.

5.6 E Option – Eared Mounting Plate



An eared mounting plate is affixed to the top surface of the UM8-40 module allowing simple chassis mounting of unit. See data sheet for dimensional drawing.

5.7 X Numbered Units – Custom Options

When modification requirements of standard units are beyond the scope of standard options a custom unit is created. To accurately capture the details Spellman creates a unique Specification Control Drawing. This drawing outlines all items (mechanical, electrical, etc) that differ from a standard unit. These units will be designated as an X numbered unit. An X numbered unit will have an X number in its model number, like X1234. Together the UM8-40 data sheet and the applicable Specification Control Drawing will detail the parameters of these proprietary custom units.

Chapter 6

MAINTENANCE

WARNING!

This power supply generates voltages that are dangerous and may be fatal.

Observe extreme caution when working with high voltage.



6.1 Periodic Servicing

The UM8-40 product family does not require any periodic maintenance or servicing.

6.2 Performance Testing

WARNING!

***High Voltage is dangerous.
Only qualified personnel should perform these tests.***

It is highly recommended that all testing comply with IEEE Standard 510-1983 IEEE Recommended Practices for Safety in High Voltage and High Power Testing. A copy of this standard can be downloaded from the Spellman High Voltage website [here](#).



Generalized high voltage test procedures are described in Bulletin STP-783, [Standard Test Procedures for High Voltage Power Supplies](#). A copy of this bulletin can be downloaded from the Spellman High Voltage website [here](#).

Test equipment includes, but is not limited to: an oscilloscope, a high impedance digital volt meter, a current meter, a ripple checker, a high voltage load, a high voltage divider (such as the Spellman HVD-100 or HVD-200) an insulated load stick and insulated short circuit stick and a safety interlocked Faraday test cage to safety conduct the tests inside of. All equipment must be properly rated for the power supply to be tested. If you do not possess the required equipment and skills necessary to safety conduct these tests do not attempt to perform these performance tests.

6.3 High Voltage Dividers

High voltage dividers for precise measurements of output voltage with accuracy up to 0.1% are available from Spellman. The HVD-100 is used for voltages up to 100KV, the HVD-200 measures up to 200KV.

The HVD Series of high voltage dividers are designed for use with differential voltmeters or high impedance digital voltmeters. The high input impedance of the HVD Series is ideal for measuring high voltage low current sources, which would be overloaded by traditional lower impedance dividers.



HVD Dividers

The HVD Series data sheet can be downloaded from the Spellman High Voltage website [here](#). Contact the Spellman Sales Department for information on price and availability.

Chapter 7

FACTORY SERVICE

7.1 Warranty Repairs

During the Warranty period, Spellman will repair all units free of charge. The Warranty is void if the unit is worked on by other than Spellman personnel. See the Warranty in the rear of this manual for more information. Follow the return procedures described in Section 7.2. The customer shall pay for shipping to and from Spellman.

7.2 Factory Service Procedures

Spellman has a well-equipped factory repair department. If a unit is returned to the factory for calibration or repair, a detailed description of the specific problem should be attached.

For all units returned for repair, please obtain an authorization to ship from the Customer Service Department, either by phone or mail prior to shipping. When you call, please state the model and serial numbers, which are on the plate on the rear of the power supply, and the purchase order number for the repair. A Return Material Authorization Code Number (RMA Number) is needed for all returns. This RMA Number should be marked clearly on the outside of the shipping container. Packages received without an RMA Number will be returned to the customer. The Customer shall pay for shipping to and from Spellman.

A preliminary estimate for repairs will be given by phone by Customer Service. A purchase order for this amount is requested upon issuance of the RMA Number. A more detailed estimate will be made when the power supply is received at the Spellman Repair Center. In the event that repair work is extensive, Spellman will call to seek additional authorization from your company before completing the repairs.

7.3 Shipping Instructions

All power supplies returned to Spellman must be sent shipping prepaid. Pack the units carefully and securely in a suitable container, preferably in the original container, if available. The power supply should be surrounded by at least four inches of shock absorbing material. Please return all associated materials, i.e. high voltage output cables, interconnection cables, etc., so that we can examine and test the entire system.

All correspondence and phone calls should be directed to:

Spellman High Voltage Electronics Corp.
475 Wireless Boulevard
Hauppauge, New York 11788
TEL: (631) 630-3000
FAX: (631) 435-1620
E-Mail: sales@Spellmanhv.com

SPELLMAN HIGH VOLTAGE ELECTRONICS

WARRANTY

Spellman High Voltage Electronics ("**Spellman**") warrants that all power supplies it manufactures will be free from defects in materials and factory workmanship, and agrees to repair or replace, without charge, any power supply that under normal use, operating conditions and maintenance reveals during the warranty period a defect in materials or factory workmanship. The warranty period is twelve (12) months from the date of shipment of the power supply. With respect to standard SL power supplies (not customized) the warranty period is thirty-six (36) months from the date of shipment of the power supply.

This warranty does not apply to any power supply that has been:

- Disassembled, altered, tampered, repaired or worked on by persons unauthorized by **Spellman**;
- subjected to misuse, negligent handling, or accident not caused by the power supply;
- installed, connected, adjusted, or used other than in accordance with the original intended application and/or instructions furnished by **Spellman**.

THE FOREGOING WARRANTY IS IN LIEU OF ALL OTHER WARRANTIES, EXPRESS OR IMPLIED, INCLUDING THOSE OF MERCHANTABILITY OR FITNESS FOR A PARTICULAR PURPOSE.

The buyer's sole remedy for a claimed breach of this warranty, and **Spellman's** sole liability is limited, at **Spellman's** discretion, to a refund of the purchase price or the repair or replacement of the power supply at **Spellman's** cost. The buyer will be responsible for shipping charges to and from **Spellman's** plant. The buyer will not be entitled to make claim for, or recover, any anticipatory profits, or incidental, special or consequential damages resulting from, or in any way relating to, an alleged breach of this warranty.

No modification, amendment, supplement, addition, or other variation of this warranty will be binding unless it is set forth in a written instrument signed by an authorized officer of **Spellman**.

Factory Service Procedures

For an authorization to ship contact **Spellman's** Customer Service Department. Please state the model and serial numbers, which are on the plate on the rear panel of the power supply and the reason for return. A Return Material Authorization Code Number (RMA number) is needed from **Spellman** for all returns. The RMA number should be marked clearly on the outside of the shipping container. Packages received without an RMA Number may delay return of the product. The buyer shall pay shipping costs to and from **Spellman**. Customer Service will provide the Standard Cost for out-of-warranty repairs. A purchase order for this amount is requested upon issuance of the RMA Number (in-warranty returns must also be accompanied by a "zero-value" purchase order). A more detailed estimate may be made when the power supply is received at **Spellman**. In the event that the cost of the actual repair exceeds the estimate, **Spellman** will contact the customer to authorize the repair.

Factory Service Warranty

Spellman will warrant for three (3) months or balance of product warranty, whichever is longer, the repaired assembly/part/unit. If the same problem shall occur within this warranty period **Spellman** shall undertake all the work to rectify the problem with no charge and/or cost to the buyer. Should the cause of the problem be proven to have a source different from the one that has caused the previous problem and/or negligence of the buyer, **Spellman** will be entitled to be paid for the repair.

Spellman Worldwide Service Centers

For a complete listing of **Spellman's** Global Service facilities please go to:
<http://www.spellmanhv.com/customerservice/service.asp>